

SOTTILE

SOLAR TECHNOLOGICAL TILE

INSTALLATION MANUAL



Once the size and geometry of the SOTTILE system has been established, the corresponding space within the traditional roofing system must be left free. In the case of existing roofs, before starting the installation of SOTTILE, it is necessary to carry out an inspection of the roof in order to check the anchoring system features. In fact, the PV tiles should be anchored above aluminium or wooden profiles 35 cm far; if they are not already installed, it is necessary to provide with the integration of these supports.



Mounting phase 1

In case of existing roof, first of all it is needed to remove the existing tiles that will be replaced by SOTTILE system, as shown in figure (Mounting phase 1). It is advisable to start with the installation of the modular supporting frame from the bottom-left side of the roof.

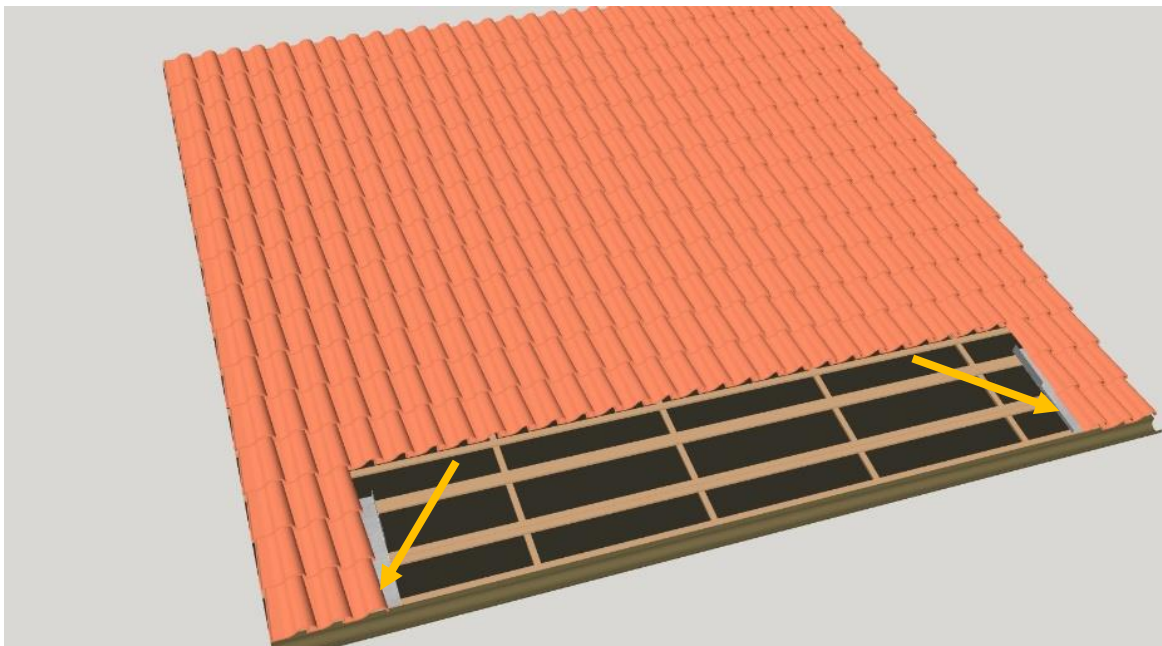

Mounting phase 2

After that, two C-profile channels are positioned on the right and left sides of the selected area (Mounting phase 2), which are essential for lateral water drainage.

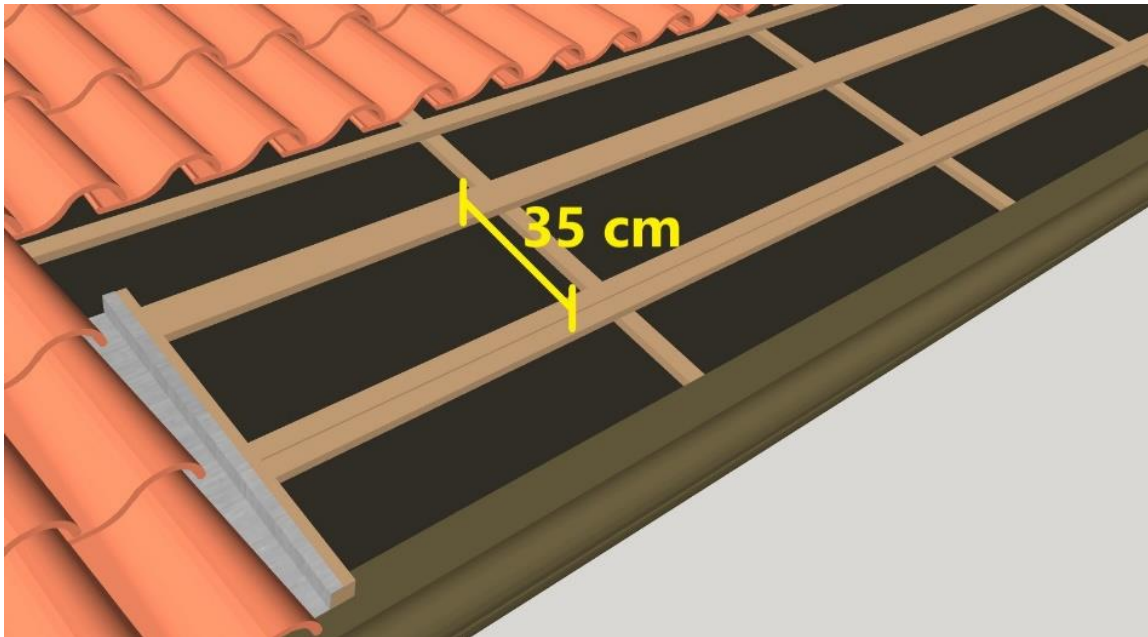

Mounting phase 3

The ideal distance between the center of each batten profile, to properly fix the modular supporting frame, should be 35 cm. Then proceed fixing the batten profile before positioning the modular supporting frame (Mounting phase 3).

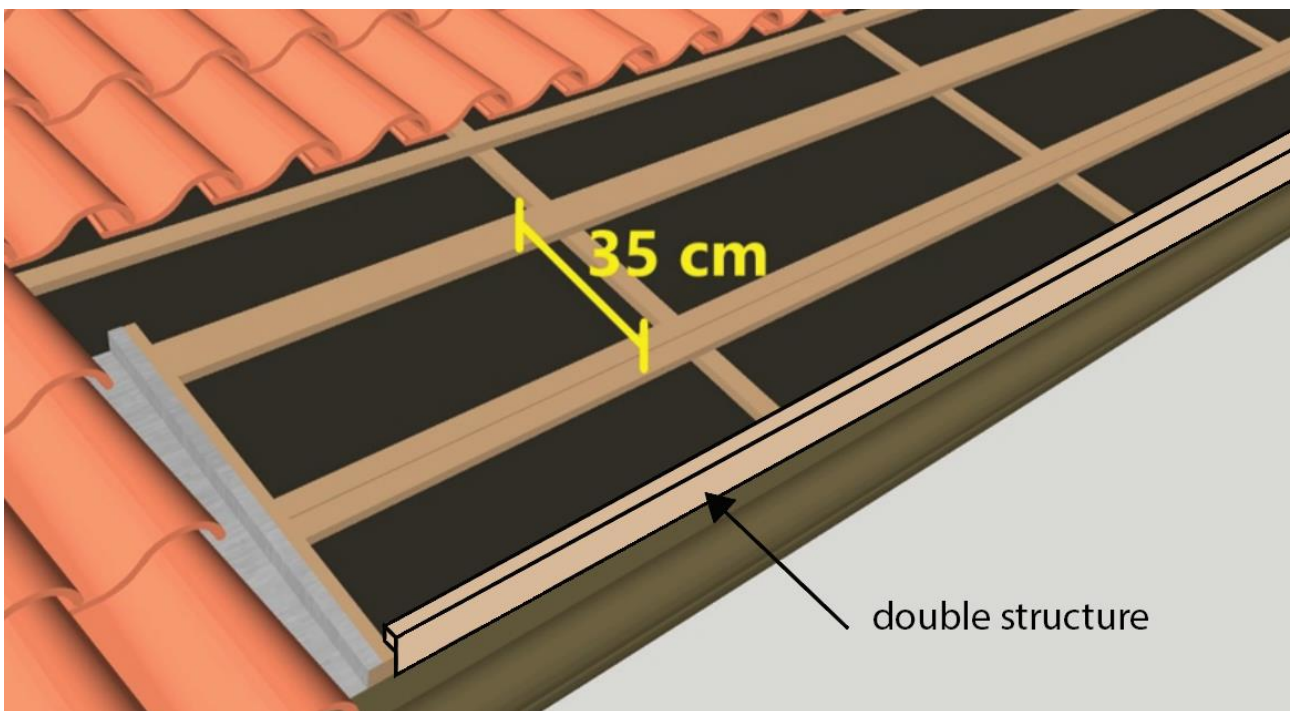

Mounting phase 4

It is important to note that the first batten is characterized by a double height (Mounting phase 4).

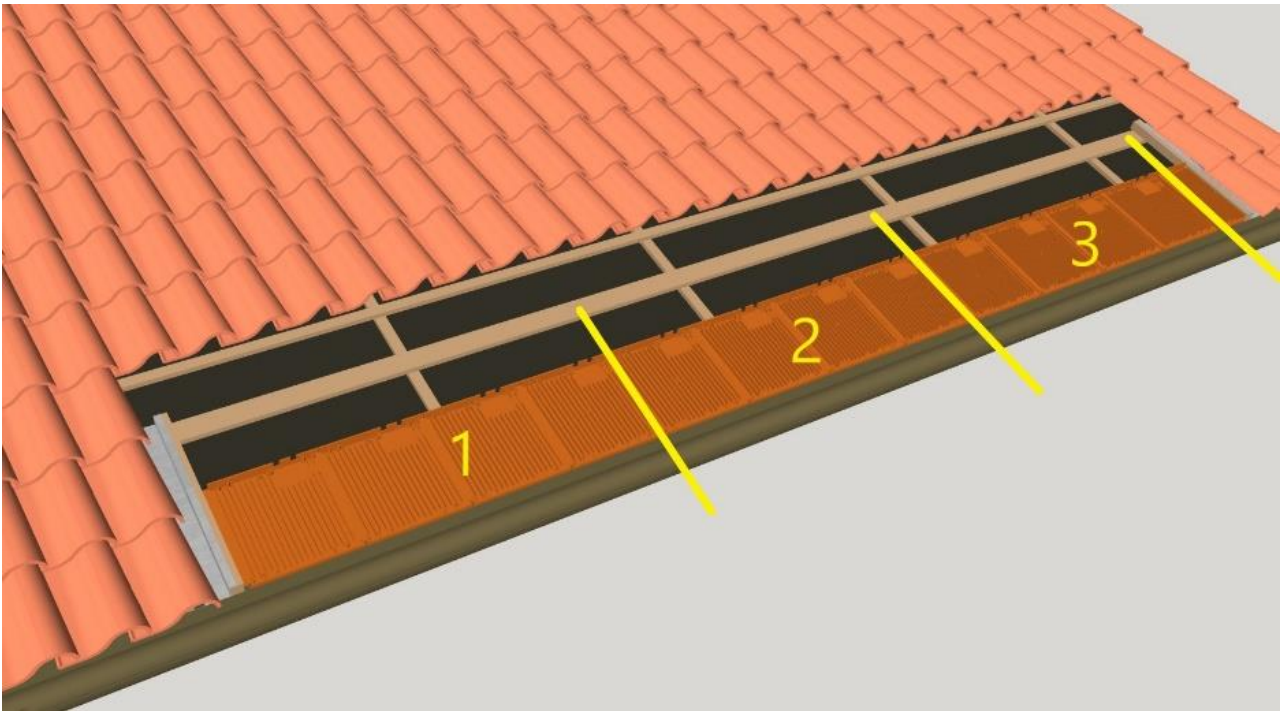

Mounting phase 5

After positioned and fixed the first 4 modular supporting frames, it is possible to repeat the operation with the other frames until the entire row is completed (Mounting phase 5).

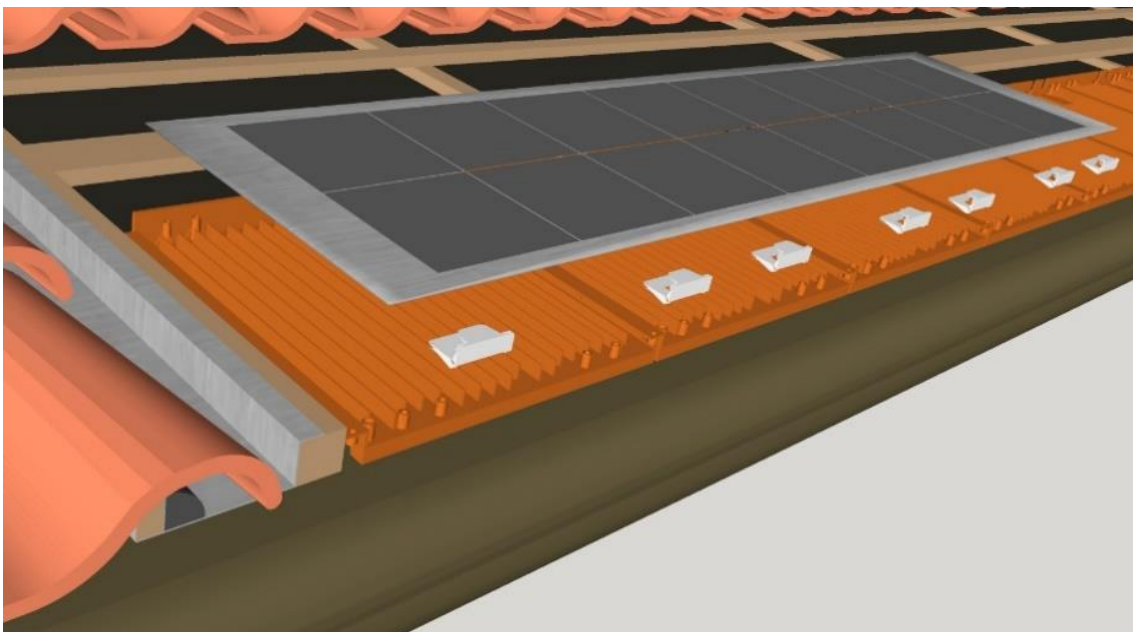

Mounting phase 6

Once all the modular support frames have been fixed, it is possible to proceed with the application of the photovoltaic laminates, always starting from the lower left corner (Mounting phase 6). The mounting of the PV module is divided in two different phases.

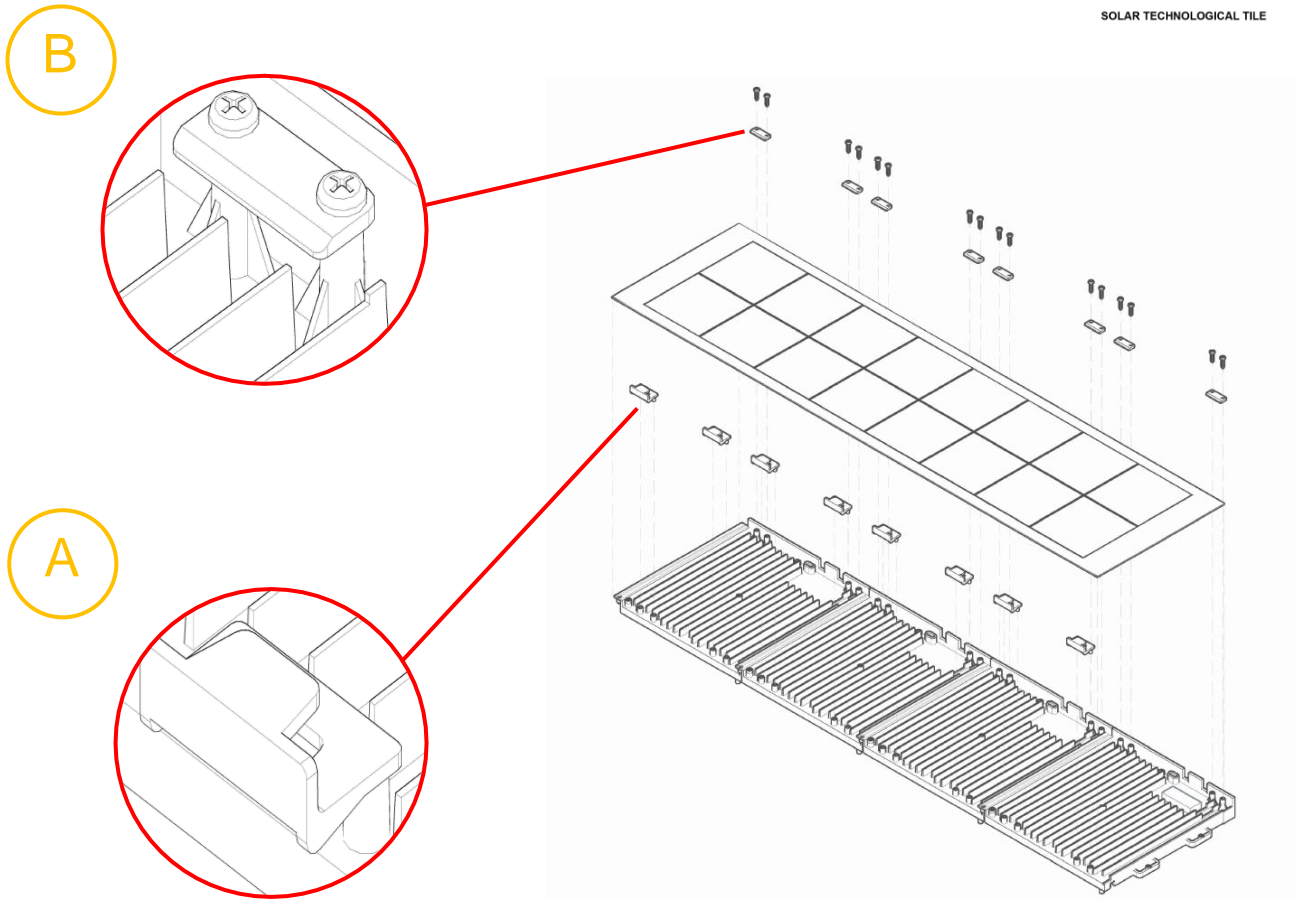

Mounting phase 7

First of all, it is necessary to fix the clips on the plastic frames in the holes provided at the bottom of the supporting frame, that are used to anchor the photovoltaic panel in the bottom part; in fact, once these clips are fixed (Mounting phase 7 - A), the panel can be positioned by tilting it into the rent in the clips, lying it down. After that, a second row of clips with screw is used to fasten of the photovoltaic modules in the upper part. As shown in the above, the clips are fixed with screws in the holes provided at the top of the supporting frame (Mounting phase 7 - B).

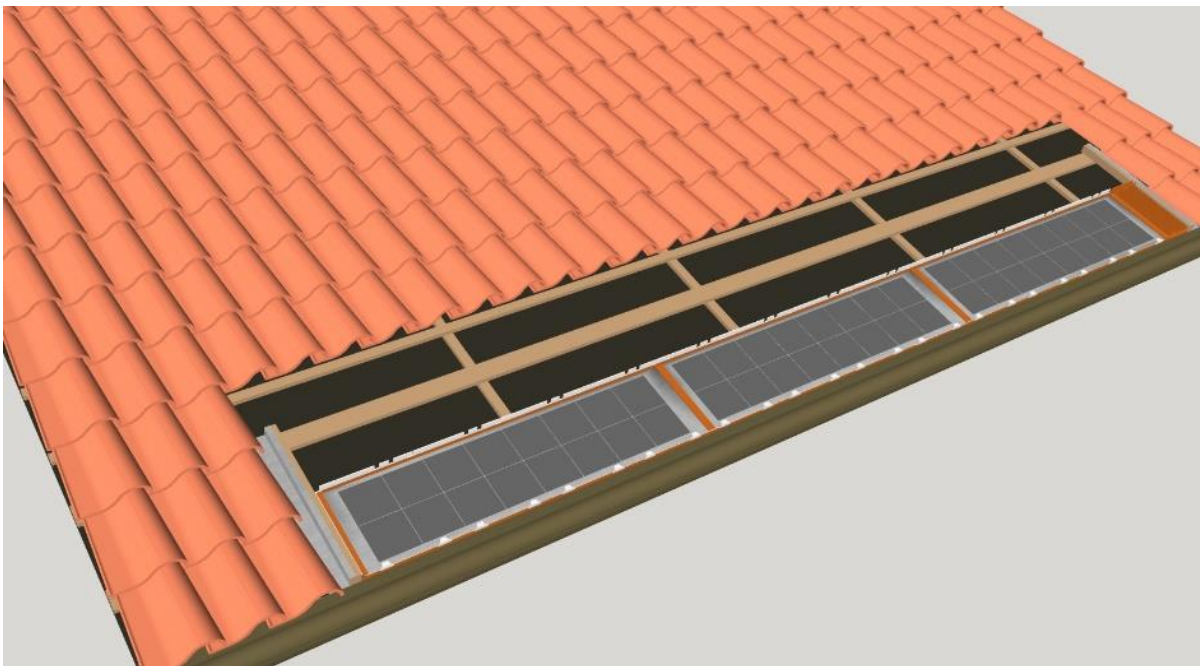

Mounting phase 8

After that it is possible to proceed with the connection of the other photovoltaic panels in order to complete the entire row (Mounting phase 8) and then to continue with the installation of the second string.

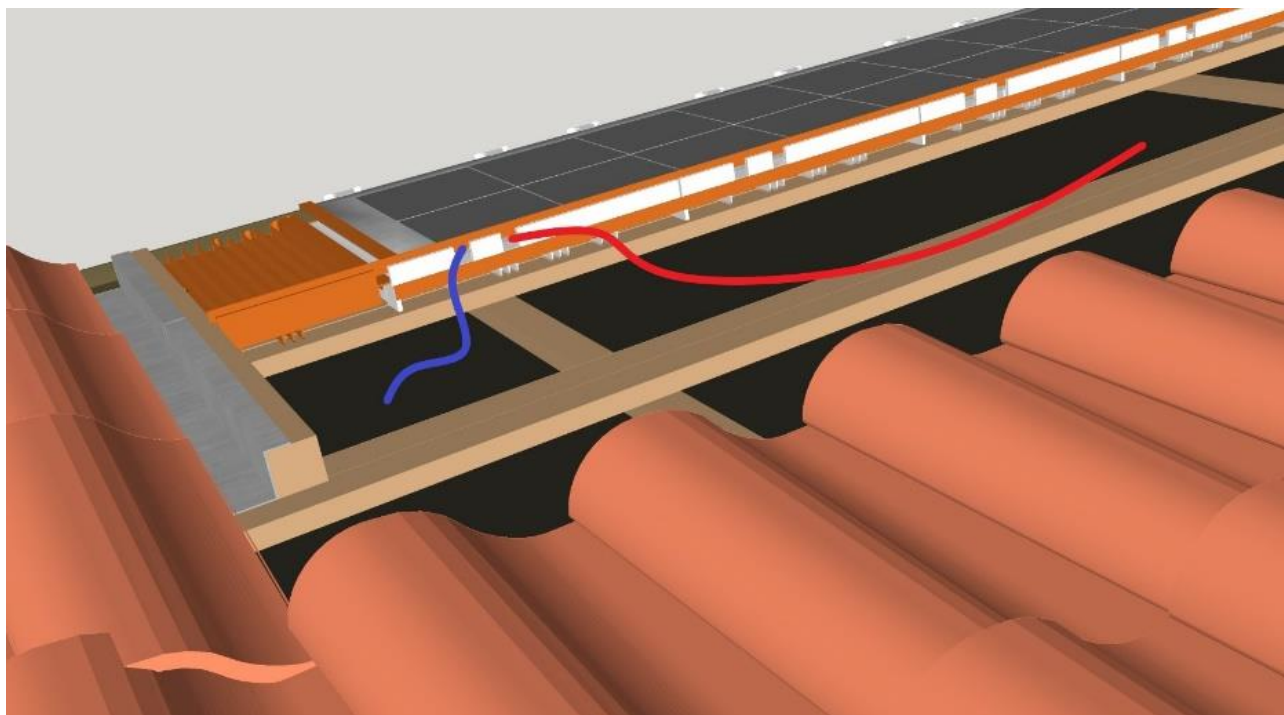

Mounting phase 9

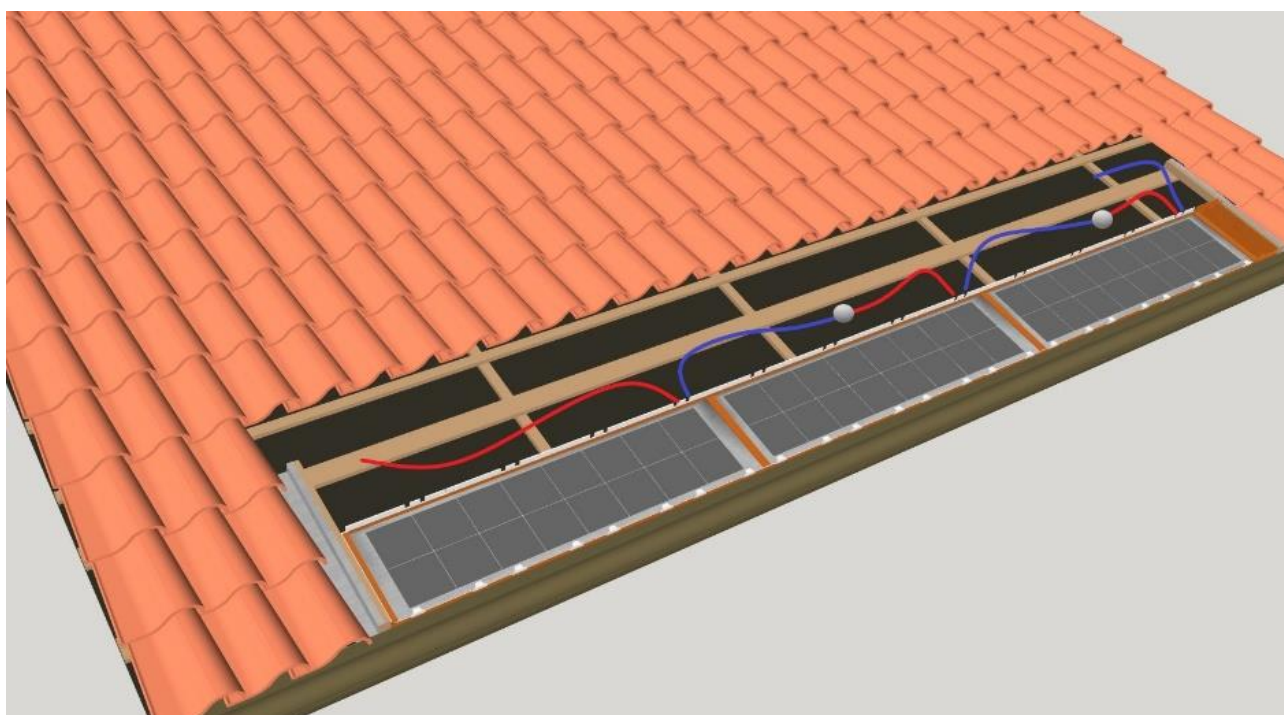

Mounting phase 10

Each photovoltaic panel is provided with two cables (Mounting phase 9) that must be correctly connected to the other modules in order to create the electrical circuit. In particular, starting from the right, the red cable of the first module will be connected with the cable coming from the upper string while the blue cable will be connected with the red cable of the adjacent module (Mounting phase 10) and so on until the first module at the bottom left from which only one blue cable will come out that will be connected to the inverter (see Mounting phase 13 for further details). It should be

noted that the maximum system voltage must not exceed 900 V, so a maximum number of 60 laminates can be connected in series.

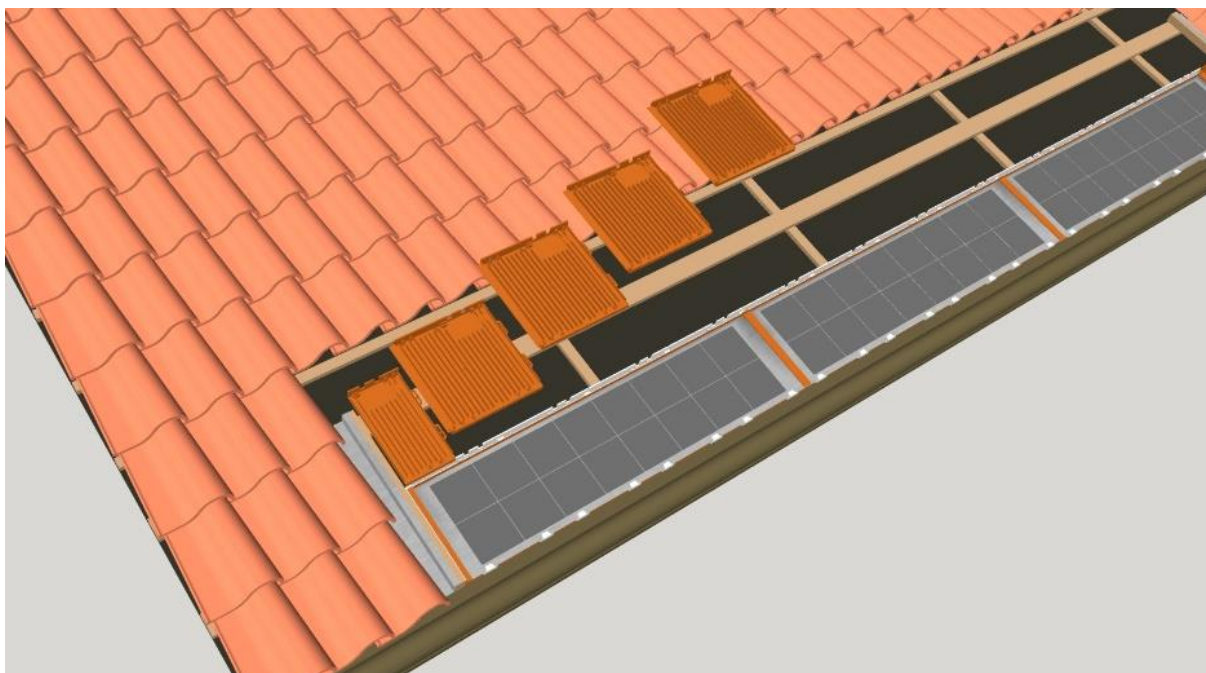

Mounting phase 11

After wiring the first string, it is possible to proceed with the installation of the second string. The procedure is similar, so starting from the left and shifting by half a module, the plastic frames of the photovoltaic cells are arranged and fixed (Mounting phase 11). Similarly, it is possible to proceed by completing the entire second string.

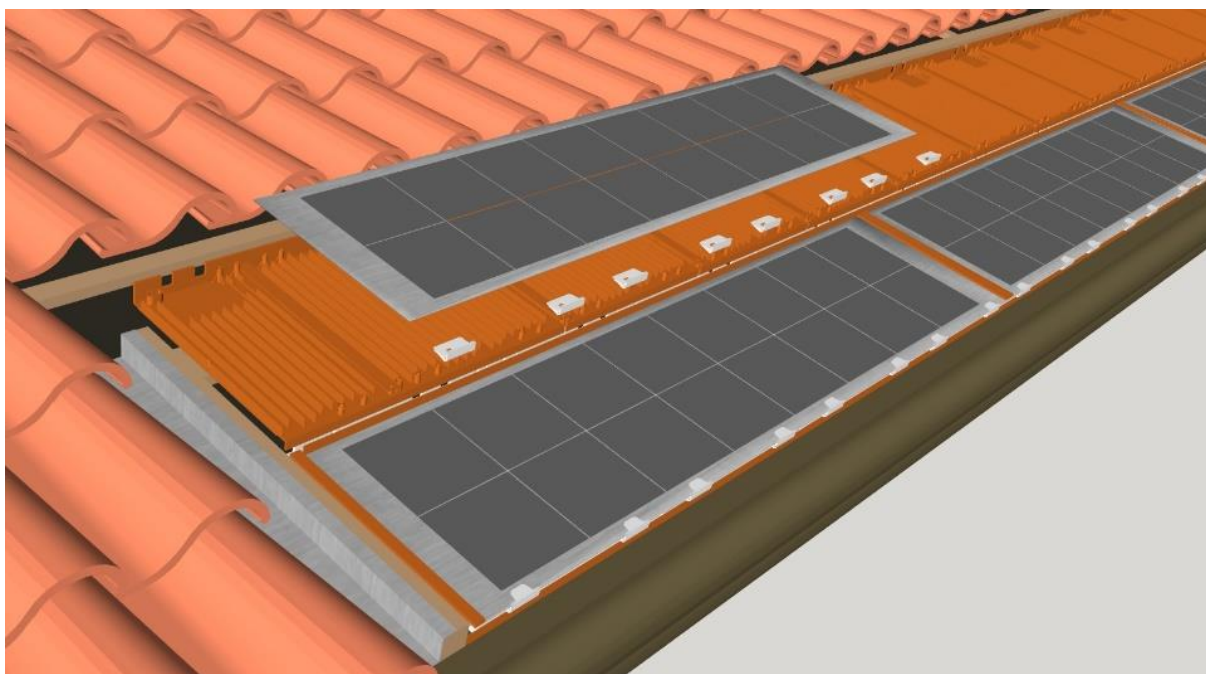

Mounting phase 12

Once the modular frames of the second string have been fixed, the photovoltaic laminates can be installed (Mounting phase 12). The procedure is identical to the one described before (Mounting phases 5-11).

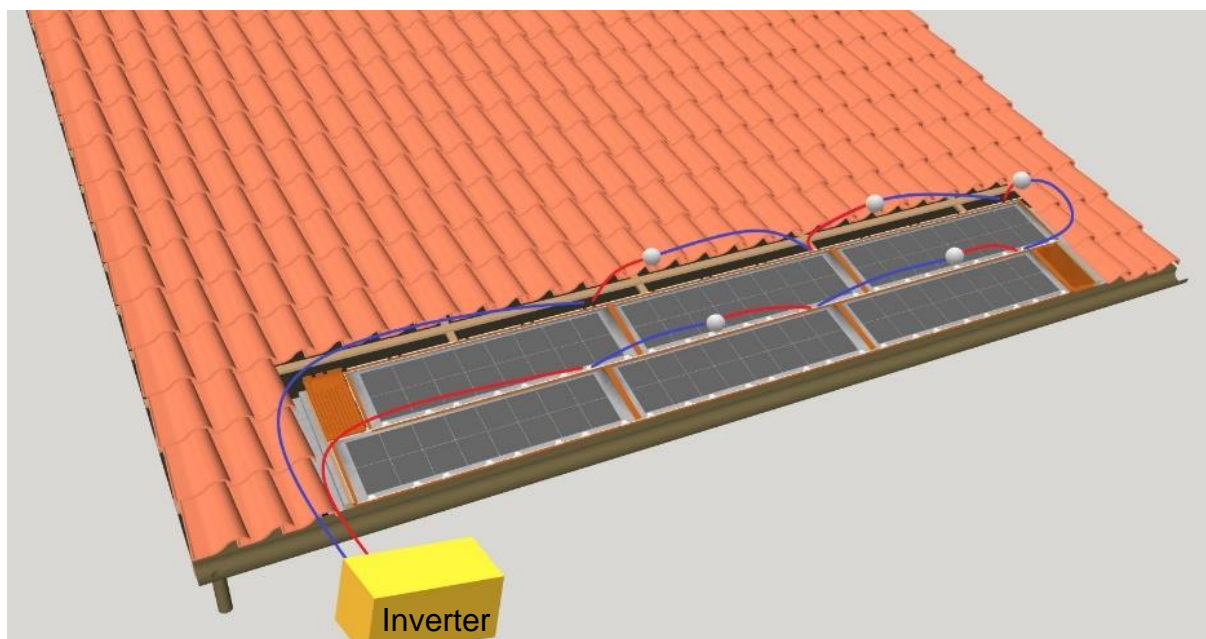

Mounting phase 13

Once the photovoltaic tiles of the second string have been fixed, it is possible to proceed with the wiring. The cables are connected following the same procedure already described: starting from the right, the red cable will connect with the red cable of the module below and the blue cable with the red of the adjacent one (Mounting phase 13). The details of PV connections are shown below.



Detail of PV connection

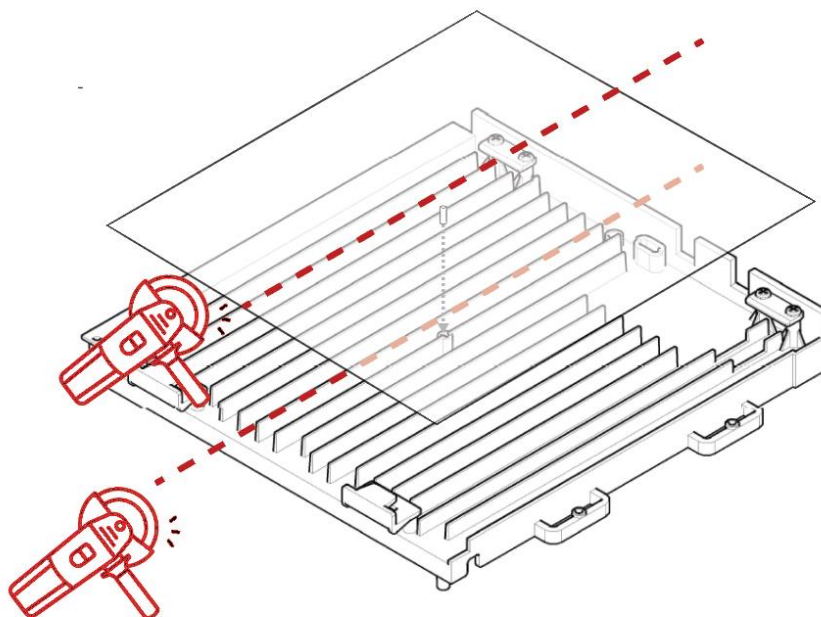

Mounting phase 14

For completion purposes of the edge of the roof, the modular supporting frame can be cut by an angle grinder (Mounting phase 14), taking care to cut both the tile and the lid at least 1 cm beyond the central connection. To keep the half lid resting on the half tile, a perimeter carter will be required.

After connecting all the photovoltaic modules to each other and to the inverter, the last row of tiles is repositioned.



Mounting phase 17

These will rest on a metal s-shaped profile that will drain the water downward, avoiding any infiltration into the roof.



SOTTILE

SOLAR TECHNOLOGICAL TILE

www.sottile.solar